

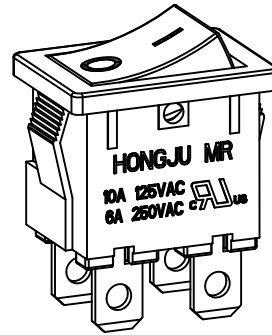

MR-6C

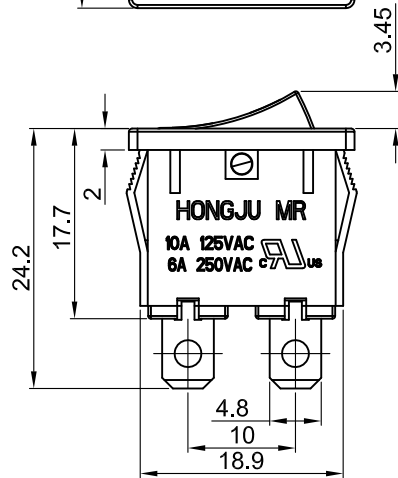
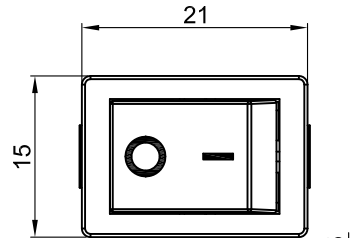
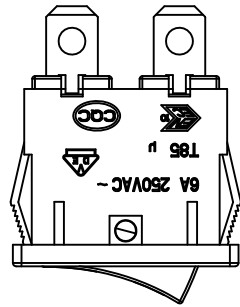

Rating: 10A 125V AC (UL CUL)
 6A 250V AC (VDE CQC CB)

Contact Resistance: 50mΩ Max
 Insulation Resistance: DC 500V 100MΩ Min
 Dielectric Strength: AC1500V 1 minute
 Electrical life: 10,000 cycles
 Operating Temperature: 0°C~85°C

CUT-OUT

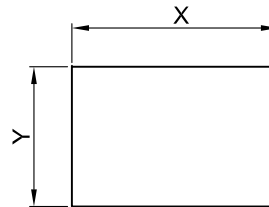

	X	Y
0.75~1.25	19.7-0.1	13.0+0.1
1.25~2.00	19.9-0.1	13.0+0.1
2.00~3.00	20.3-0.1	13.0+0.1

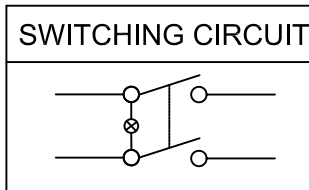
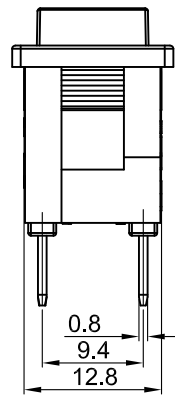

	X	0	1	2	4	5	6	7
Marking	None		ON OFF			OFF ON	开关	开关

MATERIAL:

Body:Nylon66,UL rated:94V-2 min

Actuator:PC

Terminal:Brass,silver or tin plated

公差 TOLERANCES		.X± 0.3 .XX± 0.15		角度 ± 1°		单位 DIMENSION UNIT mm.	
版本 VERSION	A0	比例尺 SCALE	NONE	日期 DATE	2019.07.15	品名 TITLE	图号 DRAWING NO
核准 APPROVED BY	王龙	核对 CHECKED BY	Z. H. B.	绘图 DRAWN BY	王立权	MR-6C-210-C5L-BR	MR-6C-210-C5L-BR_A0
版本 VER.	变更说明 CHANGE DESCRIPTION	日期 DATE	ECN NO.	APPROVED BY			